

Neben unserem hochwertigen TechnoCable-Sortiment an Litzen oder Drahtseilen aus verschiedenen Materialien in unterschiedlichen Konstruktionen und Durchmessern bieten wir Ihnen gerne auch komplette Konfektionen an. Konfektionierte Seile sind schnell und einfach zu installieren und werden nach unseren hohen Qualitätsstandards hergestellt. Zusätzlich zu unseren Standard-Seilendverbindungen entwickeln wir gerne Lösungen, die Ihren Spezifikationen und Anforderungen entsprechen.

In addition to our high quality TechnoCable range of bulk strands or wire ropes made of different materials in different constructions and diameters, we would like to offer you complete assemblies. Made-up assemblies are quick and easy to install and are produced to our high quality standards. In addition to our standard rope terminations we are pleased to develop solutions to meet your specifications and requirements.

A-Type TERMINAL (zylindrischer Nippel) | A-Type Terminal (cylindrical stop sleeve)

für Seil- \varnothing for cable \varnothing <i>mm</i>	A $\varnothing \pm 0,3$ <i>mm</i>	B $\pm 1,0$ <i>mm</i>	Werkstoff Material	Art.-Nr. alt Item No. old	Art.-Nr. neu Item No. new
0,27 – 0,45	2,5	4,0	Messing Brass	AM250405	NI000001
0,54 – 0,63	2,5	4,0	Messing Brass	AM250407	NI000002
0,72 – 0,81	3,0	4,5	Messing Brass	AM300409	NI000003
0,90 – 1,00	3,5	5,0	Messing Brass	AM350511	NI000004
1,20 – 1,50	4,2	7,0	Messing Brass	AM420716	NI000007
1,75 – 1,80	5,2	7,0	Messing Brass	AM520720	NI000008
1,50	4,0	6,0	Stahl verzinkt Galvanized steel	AZ400617	NI000021
1,50	4,0	6,0	Edelstahl Stainless steel	AS400617	NI000012
2,00	4,0	8,0	Stahl verzinkt Galvanized steel	AZ400822	NI000022
2,00	4,0	8,0	Edelstahl Stainless steel	AS400822	NI000013
2,50	5,0	12,0	Stahl verzinkt Galvanized steel	AZ501227	NI000023
2,50	5,0	12,0	Edelstahl Stainless steel	AS501227	NI000014
3,00	6,0	14,0	Stahl verzinkt Galvanized steel	AZ601433	NI000024
3,00	6,0	14,0	Edelstahl Stainless steel	AS601433	NI000015
4,00	8,0	18,0	Stahl verzinkt Galvanized steel	AZ801843	NI000025
4,00	8,0	18,0	Edelstahl Stainless steel	AS801843	NI000016
5,00	10,0	23,0	Stahl verzinkt Galvanized steel	AZ102354	NI000017
5,00	10,0	23,0	Edelstahl Stainless steel	AS102354	NI000009
6,00	12,0	27,0	Stahl verzinkt Galvanized steel	AZ122764	NI000018
6,00	12,0	27,0	Edelstahl Stainless steel	AS122764	NI000010
8,00	16,0	36,0	Stahl verzinkt Galvanized steel	AZ163685	NI000019
8,00	16,0	36,0	Edelstahl Stainless steel	AS163685	NI000011

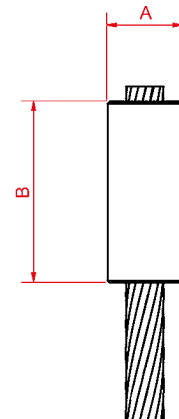

Alle angegebenen Maße im verpressten Zustand.
All measurements "after swaging".

Bitte beachten Sie die Reduzierung der Seilbruchkraft durch die Aufpressung des Terminals.
Please be aware that the minimum breaking load of the wire rope will be reduced once the end terminals have been swaged onto the rope.

Die Lieferung von unverpressten Teilen ist nicht möglich.
Delivery of individual items is not possible.

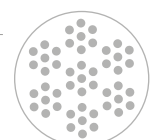

B-Type TERMINAL (Stufennippel) | B-Type Terminal (shank end stop)

für Seil- \varnothing for cable \varnothing	A $\varnothing \pm 0,3$	B $\pm 1,0$	C $\varnothing \pm 0,3$	D $\pm 1,0$	Werkstoff Material	Art.-Nr. alt Item No. old	Art.-Nr. neu Item No. new
mm	mm	mm	mm	mm			
0,27 – 0,36	2,5	4,0	3,5	5,0	Messing Brass	BMB02535	NI000026
0,45 – 0,63	2,5	4,0	3,5	5,0	Messing Brass	BMB12535	NI000032
0,72 – 0,81	3,0	4,5	5,0	5,5	Messing Brass	BMB03050	NI000028
0,90 – 1,00	3,5	5,0	6,0	6,5	Messing Brass	BMB03560	NI000029
1,20 – 1,50	4,2	7,0	7,0	8,5	Messing Brass	BMB04270	NI000030
1,75 – 1,80	5,2	7,0	8,0	8,5	Messing Brass	BMB05280	NI000031
1,50	4,0	6,0	8,0	7,5	Stahl verzinkt Galvanized steel	BZB04080	NI000044
1,50	4,0	6,0	8,0	7,5	Edelstahl Stainless steel	BSB04080	NI000036
2,00	4,0	8,0	8,0	10,0	Stahl verzinkt Galvanized steel	BZB24080	NI000052
2,00	4,0	8,0	8,0	10,0	Edelstahl Stainless steel	BSB24080	NI000043
2,50	5,0	12,0	10,0	14,5	Stahl verzinkt Galvanized steel	BZB05010	NI000045
2,50	5,0	12,0	10,0	14,5	Edelstahl Stainless steel	BSB05010	NI000037
3,00	6,0	14,0	12,0	17,0	Stahl verzinkt Galvanized steel	BZB06012	NI000046
3,00	6,0	14,0	12,0	17,0	Edelstahl Stainless steel	BSB06012	NI000038
4,00	8,0	18,0	14,0	20,0	Stahl verzinkt Galvanized steel	BZB08014	NI000047
4,00	8,0	18,0	14,0	20,0	Edelstahl Stainless steel	BSB08014	NI000039
5,00	10,0	23,0	16,0	28,0	Stahl verzinkt Galvanized steel	BZB10016	NI000048
5,00	10,0	23,0	16,0	28,0	Edelstahl Stainless steel	BSB10016	NI000040
6,00	12,0	27,0	18,0	33,0	Stahl verzinkt Galvanized steel	BZB12018	NI000049
6,00	12,0	27,0	18,0	33,0	Edelstahl Stainless steel	BSB12018	NI000041
8,00	16,0	36,0	24,0	44,0	Stahl verzinkt Galvanized steel	BZB16024	NI000051
8,00	16,0	36,0	24,0	44,0	Edelstahl Stainless steel	BSB16024	NI000042

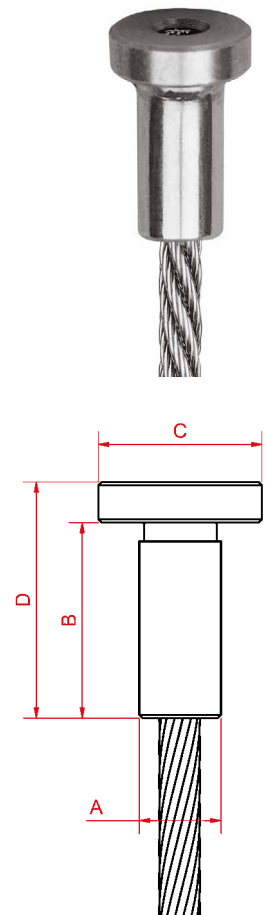

Alle angegebenen Maße im verpressten Zustand.
All measurements "after swaging".

Bitte beachten Sie die Reduzierung der Seilbruchkraft durch die Aufpressung des Terminals.
Please be aware that the minimum breaking load of the wire rope will be reduced once the end terminals have been swaged onto the rope.

Die Lieferung von unverpressten Teilen ist nicht möglich.
Delivery of individual items is not possible.

C-Type TERMINAL (Kugel) | C-Type Terminal (ball)

für Seil- \varnothing for cable \varnothing	A $\varnothing \pm 0,3$	Werkstoff Material	Art.-Nr. alt Item No. old	Art.-Nr. neu Item No. new
mm	mm			
0,27 – 0,36	1,5	Edelstahl Stainless steel	CS002715	KU000015
0,45 – 0,50	1,5	Edelstahl Stainless steel	CS004515	KU000016
0,27 – 0,36	2,0	Messing Brass	CM002720	KU000001
0,45 – 0,60	2,0	Messing Brass	CM004520	KU000003
0,27 – 0,45	2,3	Messing Brass	CM002723	KU000002
0,45 – 0,60	2,3	Messing Brass	CM004523	KU000004
0,36 – 0,81	3,2	Messing Brass	CM008132	KU000006
1,00	3,2	Messing Brass	CM010032	KU000007
1,20	3,2	Messing Brass	CM012032	KU000009
0,63 – 1,00	4,0	Messing Brass	CM008040	KU000005
1,20 – 1,50	4,0	Messing Brass	CM017040	KU000012
0,63 – 1,00	4,8	Messing Brass	CM010048	KU000008
1,20 – 1,50	4,8	Messing Brass	CM016048	KU000011
1,20 – 1,50	6,0	Messing Brass	CM012060	KU000010
1,76 – 2,00	4,8	Messing Brass	CM022048	KU000013
1,76 – 2,00	6,0	Messing Brass	CM022060	KU000014
2,00	6,0	Stahl verzinkt Galvanized steel	CZ020060	KU000030
2,00	6,0	Edelstahl Stainless steel	CS020060	KU000017
2,50	8,0	Stahl verzinkt Galvanized steel	CZ025080	KU000031
2,50	8,0	Edelstahl Stainless steel	CS025080	KU000018
3,00	8,0	Stahl verzinkt Galvanized steel	CZ030080	KU000032
3,00	8,0	Edelstahl Stainless steel	CS030080	KU000019
4,00	10,0	Stahl verzinkt Galvanized steel	CZ040010	KU000033
4,00	10,0	Edelstahl Stainless steel	CS040010	KU000020

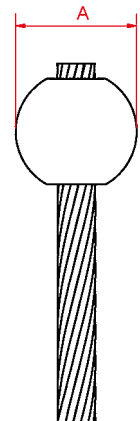

Alle angegebenen Maße im verpressten Zustand.
All measurements "after swaging".

Bitte beachten Sie die Reduzierung der Seilbruchkraft durch die Aufpressung des Terminals.
Please be aware that the minimum breaking load of the wire rope will be reduced once the end terminals have been swaged onto the rope.

Die Lieferung von unverpressten Teilen ist nicht möglich.
Delivery of individual items is not possible.

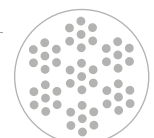

D-Type TERMINAL (Kabelschuh) | D-Type Terminal (Eyelet)

für Seil- \varnothing for cable \varnothing	A $\pm 1,0$	B $\pm 0,3$	C $\pm 0,2$	D $\pm 1,0$	E $\pm 1,0$	Werkstoff Material	Art.-Nr. alt Item No. old	Art.-Nr. neu Item No. new
mm	mm	mm	mm	mm	mm			
0,36 – 1,00	6,6	3,6	1,1	3,3	14,7	Edelstahl Stainless steel	DS036360	KA000001
0,36 – 1,00	6,6	4,2	1,1	3,3	14,7	Edelstahl Stainless steel	DS036420	KA000002
0,36 – 1,00	9,5	5,6	1,1	5,0	17,0	Edelstahl Stainless steel	DS036560	KA000003
0,36 – 1,00	9,5	6,5	1,1	5,0	17,0	Edelstahl Stainless steel	DS036650	KA000004
1,20 – 2,00	10,7	3,6	1,5	8,1	25,4	Edelstahl Stainless steel	DS120360	KA000005
1,20 – 2,00	10,7	4,8	1,5	8,1	25,4	Edelstahl Stainless steel	DS120480	KA000006
1,20 – 2,00	10,7	5,6	1,5	8,1	25,4	Edelstahl Stainless steel	DS120560	KA000007
1,20 – 2,00	10,7	6,6	1,5	8,1	25,4	Edelstahl Stainless steel	DS120660	KA000008
1,20 – 2,00	10,7	6,6	1,5	8,1	25,4	Stahl verz. Galv. steel	DZ120660	KA000013
2,00 – 2,50	19,0	9,6	2,3	12,0	30,2	Stahl verz. Galv. steel	DZ200960	KA000015
2,00 – 2,50	19,0	12,7	2,3	12,0	30,2	Stahl verz. Galv. steel	DZ200127	KA000014
2,00 – 2,50	19,0	9,6	2,3	12,0	30,2	Edelstahl Stainless steel	DS200960	KA000010
2,00 – 2,50	19,0	12,7	2,3	12,0	30,2	Edelstahl Stainless steel	DS200127	KA000009
3,00	21,6	9,6	3,2	15,2	49,3	Stahl verz. Galv. steel	DZ300960	KA000017
3,00	21,6	12,7	3,2	15,2	49,3	Stahl verz. Galv. steel	DZ300127	KA000016
3,00	21,6	9,6	3,2	15,2	49,3	Edelstahl Stainless steel	DS300960	KA000012
3,00	21,6	12,7	3,2	15,2	49,3	Edelstahl Stainless steel	DS300127	KA000011
4,00 – 5,00	25,4	9,6	4,8	16,0	60,5	Stahl verz. Galv. steel	DZ400960	KA000024
4,00 – 5,00	25,4	12,7	4,8	16,0	60,5	Stahl verz. Galv. steel	DZ400127	KA000023
4,00 – 5,00	25,4	9,6	4,8	16,0	60,5	Edelstahl Stainless steel	DS400960	KA000020
4,00 – 5,00	25,4	12,7	4,8	16,0	60,5	Edelstahl Stainless steel	DS400127	KA000019

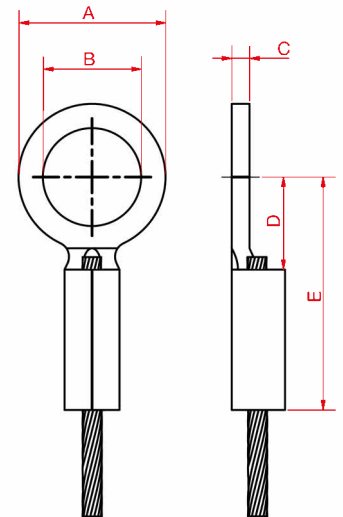

Alle angegebenen Maße im verpressten Zustand.
All measurements "after swaging".

Bitte beachten Sie die Reduzierung der Seilbruchkraft durch die Aufpressung des Terminals.
Please be aware that the minimum breaking load of the wire rope will be reduced once the end terminals have been swaged onto the rope.

Die Lieferung von unverpressten Teilen ist nicht möglich.
Delivery of individual items is not possible.

Weitere Ausführungen auf Anfrage.
Other configurations on request.

E-Type TERMINAL (Gewindeendstück) | E-Type Terminal (thread terminal)

für Seil- \varnothing for cable \varnothing	A	B $\pm 1,0$	C $\pm 2,0$	SW $\pm 0,3$	Werkstoff Material	Art.-Nr. alt Item No. old	Art.-Nr. neu Item No. new
mm		mm	mm	mm			
0,27 – 0,45	M3	20,0	28,0	2,3	Messing Brass	EM027320	GE000001
0,27 – 0,45	M4	12,0	18,0	1,6*	Messing Brass	EM027412	GE000002
0,27 – 0,45	M4	30,0	40,0	2,3	Messing Brass	EM027430	GE000003
0,54 – 0,63	M4	20,0	30,0	2,3	Messing Brass	EM054420	GE000004
0,54 – 0,63	M4	35,0	45,0	2,3	Messing Brass	EM054435	GE000005
0,72 – 0,81	M5	25,0	40,0	2,8	Messing Brass	EM072525	GE000006
0,72 – 0,81	M5	40,0	55,0	2,8	Messing Brass	EM072540	GE000007
0,90 – 1,00	M5	30,0	45,0	3,2	Messing Brass	EM090530	GE000008
0,90 – 1,00	M5	50,0	65,0	3,2	Messing Brass	EM090550	GE000009
1,20 – 1,50	M6	30,0	42,0	4,0	Messing Brass	EM120630	GE000010
1,20 – 1,50	M6	50,0	65,0	4,0	Messing Brass	EM120650	GE000011
1,75 – 1,80	M8	30,0	45,0	5,0	Messing Brass	EM175830	GE000012
1,75 – 1,80	M8	50,0	65,0	5,0	Messing Brass	EM175850	GE000013
2,00	M6	30,0	47,0	4,3	Stahl verzinkt Galvanized steel	EZ200630	GE000028
2,00	M6	50,0	67,0	4,3	Stahl verzinkt Galvanized steel	EZ200650	GE000029
2,00	M6	30,0	47,0	4,3	Edelstahl Stainless steel	ES200630	GE000014
2,00	M6	50,0	67,0	4,3	Edelstahl Stainless steel	ES200650	GE000015
2,50	M6	30,0	50,0	4,3	Stahl verzinkt Galvanized steel	EZ250630	GE000030
2,50	M6	50,0	70,0	4,3	Stahl verzinkt Galvanized steel	EZ250650	GE000031
2,50	M6	30,0	50,0	4,3	Edelstahl Stainless steel	ES250630	GE000016
2,50	M6	50,0	70,0	4,3	Edelstahl Stainless steel	ES250650	GE000017
3,00	M8	30,0	53,0	6,0	Stahl verzinkt Galvanized steel	EZ300830	GE000032
3,00	M8	50,0	73,0	6,0	Stahl verzinkt Galvanized steel	EZ300850	GE000033
3,00	M8	30,0	53,0	6,0	Edelstahl Stainless steel	ES300830	GE000018
3,00	M8	50,0	73,0	6,0	Edelstahl Stainless steel	ES300850	GE000019
4,00	M8	40,0	70,0	7,0	Stahl verzinkt Galvanized steel	EZ400840	GE000034
4,00	M8	70,0	100,0	7,0	Stahl verzinkt Galvanized steel	EZ400870	GE000035
4,00	M8	40,0	70,0	7,0	Edelstahl Stainless steel	ES400840	GE000020
4,00	M8	70,0	100,0	7,0	Edelstahl Stainless steel	ES400870	GE000021
5,00	M10	40,0	75,0	8,7	Stahl verzinkt Galvanized steel	EZ500140	GE000036
5,00	M10	70,0	105,0	8,7	Stahl verzinkt Galvanized steel	EZ500170	GE000037
5,00	M10	40,0	75,0	8,7	Edelstahl Stainless steel	ES500140	GE000022
5,00	M10	70,0	105,0	8,7	Edelstahl Stainless steel	ES500170	GE000023
6,00	M12	40,0	80,0	10,7	Stahl verzinkt Galvanized steel	EZ600140	GE000038
6,00	M12	70,0	110,0	10,7	Stahl verzinkt Galvanized steel	EZ600170	GE000039
6,00	M12	40,0	80,0	10,7	Edelstahl Stainless steel	ES600140	GE000024
6,00	M12	70,0	110,0	10,7	Edelstahl Stainless steel	ES600170	GE000025
8,00	M16	40,0	90,0	14,5	Stahl verzinkt Galvanized steel	EZ800140	GE000040
8,00	M16	70,0	120,0	14,5	Stahl verzinkt Galvanized steel	EZ800170	GE000041
8,00	M16	40,0	90,0	14,5	Edelstahl Stainless steel	ES800140	GE000026
8,00	M16	70,0	120,0	14,5	Edelstahl Stainless steel	ES800170	GE000027

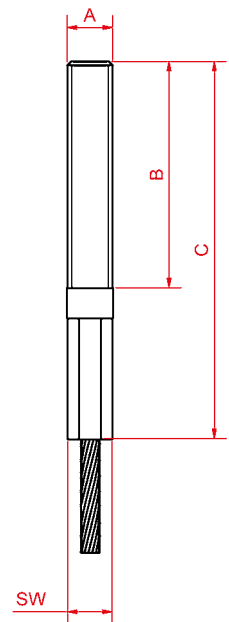

*vierkant verpresst
*square swaged

Alle angegebenen Maße im verpressten Zustand.
All measurements "after swaging".

Bitte beachten Sie die Reduzierung der Seilbruchkraft durch die Aufpressung des Terminals.
Please be aware that the minimum breaking load of the wire rope will be reduced once the end terminals have been swaged onto the rope.

Die Lieferung von unverpressten Teilen ist nicht möglich.
Delivery of individual items is not possible.

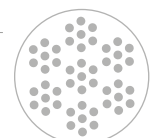

Beim Verpressen von Schlaufen ergeben sich aufgrund des Klemmenwerkstoffs und des verwendeten Seils (Seile mit Stahleinlage oder Fasereinlage) unterschiedliche Abmessungen.

When swaging the loops, slightly different sizes of the loop occur depending on the ferrule material and the rope construction used.

Schlaufe für Seile mit Stahleinlage | Soft eye for wire rope with steel core

für Seil- \emptyset for cable \emptyset	A $\emptyset \pm 0,3$	B $\pm 1,0$	Werkstoff Material	Art.-Nr. alt Item No. old	Art.-Nr. neu Item No. new
mm	mm	mm			
0,27 – 0,50	SW 1,6 vierkant square	6,0	Kupfer verzinkt tinned copper	R0502720	KL000019
0,54 – 1,10	3,0	7,0	Aluminium Aluminium	T1005430	KL000020
0,54 – 1,10	3,2	7,5	Edelstahl Stainless steel	P5E00010	KL000010
1,20 – 1,50	4,2	8,0	Aluminium Aluminium	T1512042	KL000021
1,20 – 1,50	4,4	7,0	Edelstahl Stainless steel	P5E00015	KL000011
1,60 – 2,00	4,2	9,5	Aluminium Aluminium	T2016042	KL000022
1,60 – 2,00	4,6	10,5	Edelstahl Stainless steel	P5E00020	KL000012
2,5	6,0	14,5	Aluminium Aluminium	P5000030	KL000002
2,5	5,6	11,0	Edelstahl Stainless steel	P5E00025	KL000013
3,0	7,0	17,5	Aluminium Aluminium	P5000040	KL000003
3,0	6,5	12,0	Edelstahl Stainless steel	P5E00030	KL000014
4,0	9,0	22,0	Aluminium Aluminium	P5000045	KL000004
4,0	8,6	15,5	Edelstahl Stainless steel	P5E00040	KL000015
5,0	12,0	27,5	Aluminium Aluminium	P5000060	KL000006
5,0	11,0	21,6	Edelstahl Stainless steel	P5E00050	KL000016
6,0	13,0	32,5	Aluminium Aluminium	P5000065	KL000007
6,0	14,0	25,5	Edelstahl Stainless steel	P5E00060	KL000017
8,0	18,0	32,0	Aluminium Aluminium	P5000090	KL000009
8,0	18,0	33,5	Edelstahl Stainless steel	P5E00080	KL000018

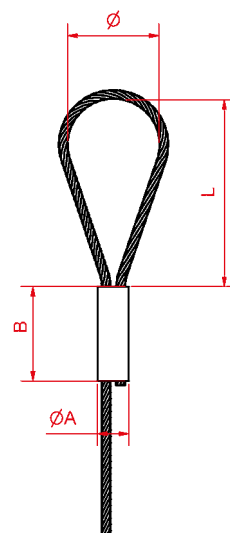

Schlaufe für Seile mit Fasereinlage | Soft eye for wire rope with fibre core

für Seil- \emptyset for cable \emptyset	A $\emptyset \pm 0,5$	B $\pm 1,0$	Werkstoff Material	Art.-Nr. alt Item No. old	Art.-Nr. neu Item No. new
mm	mm	mm			
1,5	4,2	8,0	Aluminium Aluminium	T1512042	KL000021
2,0	4,2	10,5	Aluminium Aluminium	T2016042	KL000022
2,5	5,0	13,0	Aluminium Aluminium	P5000025	KL000001
3,0	6,0	15,0	Aluminium Aluminium	P5000030	KL000002
4,0	8,0	20,5	Aluminium Aluminium	P5000040	KL000003
5,0	10,0	27,5	Aluminium Aluminium	P5000050	KL000005
6,0	12,0	31,0	Aluminium Aluminium	P5000060	KL000006
8,0	16,0	41,0	Aluminium Aluminium	P5000080	KL000008

Alle angegebenen Maße im verpressten Zustand.
All measurements "after swaging".

Bitte beachten Sie die Reduzierung der Seilbruchkraft durch die Aufpressung des Terminals.

Please be aware that the minimum breaking load of the wire rope will be reduced once the end terminals have been swaged onto the rope.

Die Lieferung von unverpressten Teilen ist nicht möglich.

Delivery of individual items is not possible.

Bitte geben Sie bei der Bestellung immer den Durchmesser \emptyset und die Länge L der Schlaufe in mm an. Standardmäßig wird die Länge L mit dem 12-fachen Seildurchmesser und der Schlaufendurchmesser \emptyset mit der halben Länge L berechnet.

Please specify the eye size (length L and diameter \emptyset) with your order. The length L is normally dimensioned with 12 times the rope diameter and the soft eye diameter \emptyset with half of the length L.

Die Kauschen werden zusammen mit den Pressklemmen verwendet, um das Seil vor Verschleiß zu schützen. Sie verteilen die Last am Drahtseil auf eine größere Fläche, reduzieren somit die Flächenpressung und dadurch das Verschleißverhalten des Drahtseils.

Thimbles are used together with ferrules to protect the rope from wear. The thimble distributes the load equally to the rope and therefore increases working life.

Schlaufe mit Kausche | Soft eye with thimble

für Seil- \varnothing for cable \varnothing	C $\pm 1,0$	D $\pm 2,0$	E* $\pm 1,0$	F $\pm 0,5$	Werkstoff Material	Art.-Nr. alt Item No. old	Art.-Nr. neu Item No. new
mm	mm	mm	mm	mm			
0,45 – 1,20	11,5	5,0	3,0	7,5	Edelstahl Stainless steel	KSS45120	KS000025
1,20 – 2,00	25,5	8,6	4,0	14,6	Edelstahl Stainless steel	KSS12020	KS000026
2,5	31	12,0	5,7	21,0	Stahl verzinkt Galvanized steel	KZA00025	KS000002
2,5	24	10,0	4,4	18,0	Edelstahl Stainless steel	KSS00025	KS000019
3,0	32	12,0	5,7	22,0	Stahl verzinkt Galvanized steel	KZA00030	KS000003
3,0	26	10,0	4,4	18,0	Edelstahl Stainless steel	KSS00030	KS000019
4,0	35	14,0	7,9	25,0	Stahl verzinkt Galvanized steel	KZA00040	KS000004
4,0	30	11,0	6,4	21,0	Edelstahl Stainless steel	KSS00040	KS000020
5,0	40	16,0	9,5	30,5	Stahl verzinkt Galvanized steel	KZA00050	KS000005
5,0	35	13,0	8,0	26,0	Edelstahl Stainless steel	KSS00050	KS000021
6,0	45	18,0	9,2	35,5	Stahl verzinkt Galvanized steel	KZA00060	KS000006
6,0	43	16,0	9,2	31,0	Edelstahl Stainless steel	KSS00060	KS000022

*Maß E = Kauschenbreite
*Size E = Thimble width

Bitte beachten: Die Maße A und B sind gleich den Klemmenmaßen bei Schlaufen (Seite 26). Standardmäßig liefern wir Edelstahlseile und Kauschen aus Edelstahl mit Edelstahlklemme, sowie verzinkte Seile und Kauschen aus verzinktem Stahl mit Aluminiumpressklemmen. Wollen Sie abweichend vom Standard eine andere Klemme, so geben Sie dies bitte bei der Bestellung an. Ausnahme Seil- \varnothing 0,45 – hier verwenden wir Klemmen Kupfer verzinkt KL000019.

Please note: The dimensions A and B are equal to the dimensions of the ferrules on page 26. Standardwise we supply stainless steel ropes with thimbles and ferrules made out of stainless steel. Galvanized ropes are supplied with galvanized thimbles and ferrules made out of aluminium. If you would like thimbles and ferrules in other materials please specify this on your order. Exception: cable- \varnothing 0,45 – for which we only use copper ferrule KL000019.

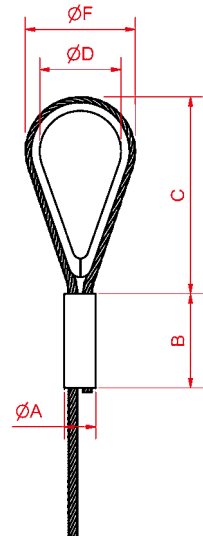

Alle angegebenen Maße im verpressten Zustand.
All measurements "after swaging".

Bitte beachten Sie die Reduzierung der Seilbruchkraft durch die Aufpressung des Terminals.
Please be aware that the minimum breaking load of the wire rope will be reduced once the end terminals have been swaged onto the rope.

Die Lieferung von unverpressten Teilen ist nicht möglich.
Delivery of individual items is not possible.

